

# STAX 6MM

Wire modules in order as shown on the diagram

Maximum Amperage per lead: 16 Amps @120V

STAX Boost Power Continuation Cable found in (Yellow Labeled bag). Required after each 12th consecutive module per display face.

STAX Controller Cable Kit found in (Red Labeled bag). One cable kit per display face. Includes one Primary Controller Power Cable and one 1st Module Power/Data Cable

Multiple leads can be connected together and share a breaker. Multiple circuits may share the same neutrals. Please follow local NEC Codes & regulations

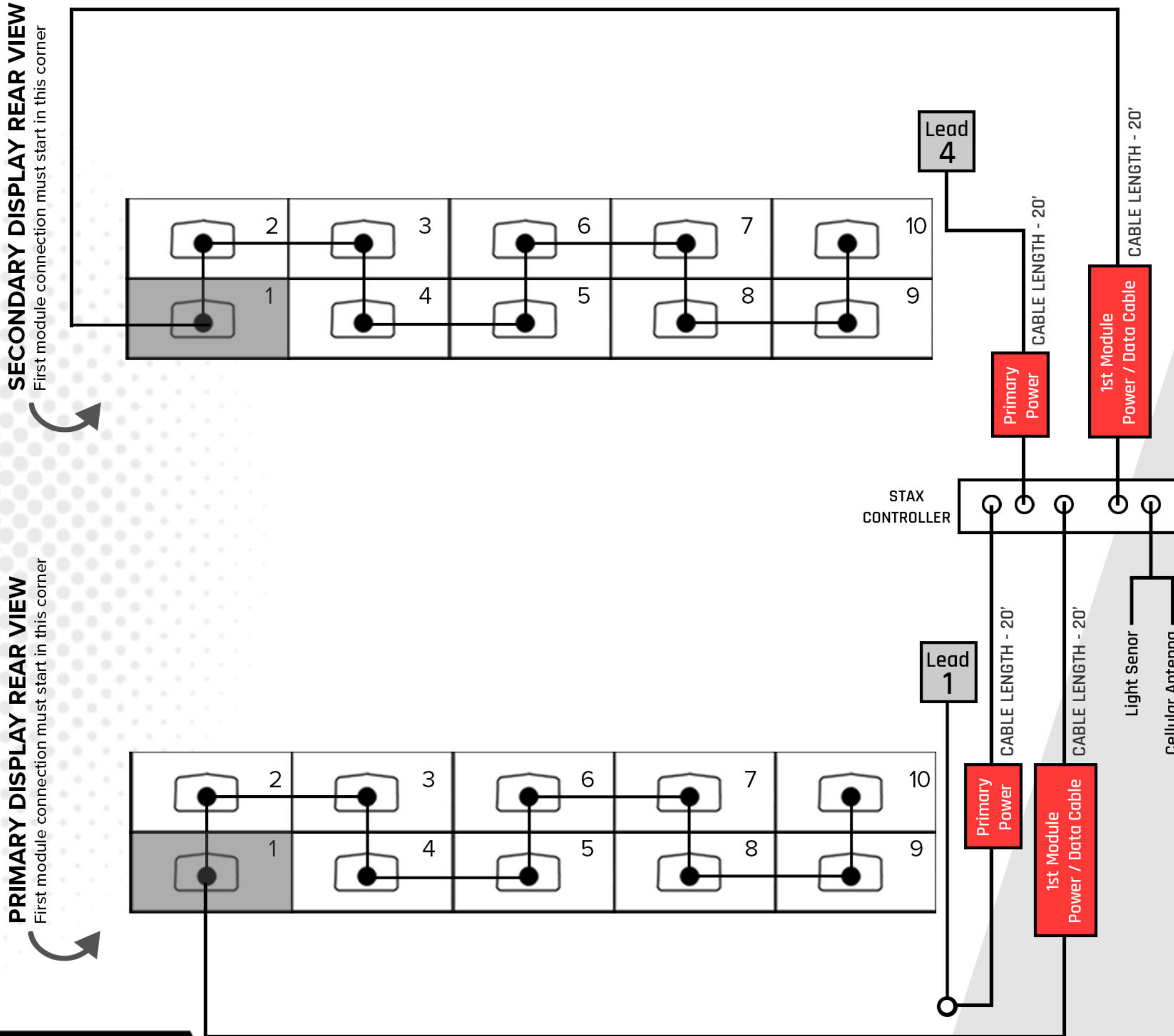

**SECONDARY DISPLAY REAR VIEW**  
First module connection must start in this corner

**PRIMARY DISPLAY REAR VIEW**  
First module connection must start in this corner

Primary Display

Lead	Max Watts	Avg Watts	Amps @120V
4	798	427	6.7
5			
6			
Total	798	427	6.7

Secondary Display

Lead	Max Watts	Avg Watts	Amps @120V
4	798	427	6.7
5			
6			
Total	798	427	6.7

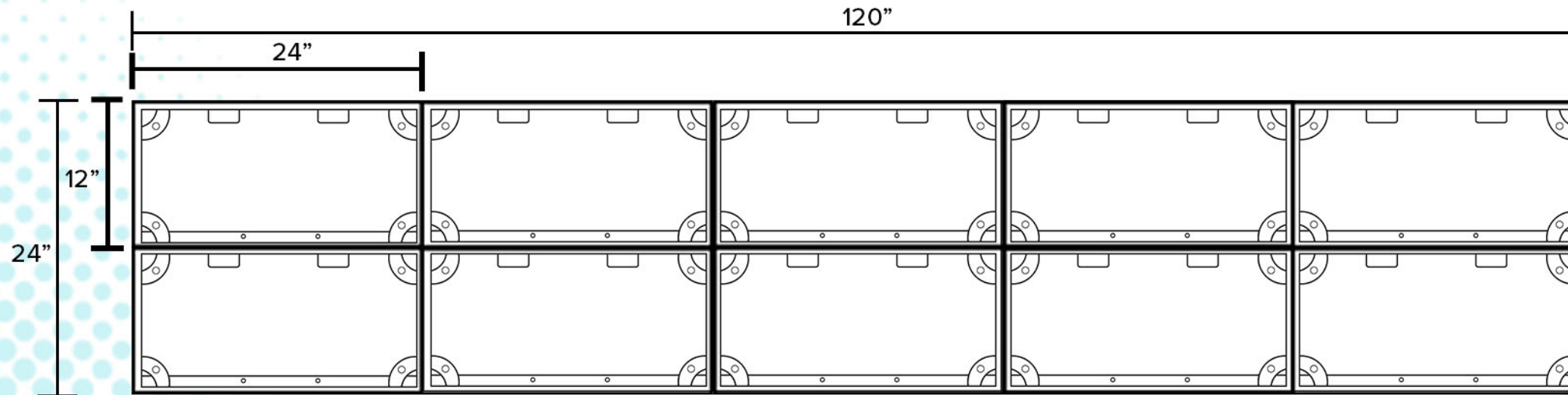

Must lift final assembled sign with a minimum of two lifting points. 330 maximum lbs per lifting pin.

Parts List	Single Face	Double Face
Module	10	20
Controller	1	1
Controller Cable Kit	1	2
Boost Power Cable	0	0

AND

Option 1: Single Frame Assembly	Single Face	Double Face
1' x 2' Frame	10	20
1' x 2' Frame Door (Optional)	10	20

OR

Option 2: Mixed Frame Assembly	Single Face	Double Face
1' x 2' Frame	2	4
1' x 2' Frame Door (Optional)	2	4
2' x 4' Frame	2	4
2' x 4' Frame Door (Optional)	4	8

## PRIMARY DISPLAY REAR VIEW

### SHACKLE ATTACHMENT

The shackle cables should connect to the lifting pins at an angle of 30 degrees or less to prevent damage to the cabinet frame. Spreader bar should be used when three or more lifting pins are required per face.

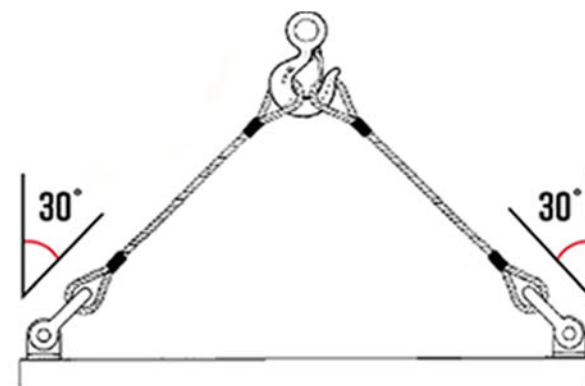

Display Weight	Maximum lbs	Maximum lbs per lifting pin	Number of Pins Per Face
Single Face	163.6	330	2
Double Face	327.2	N/A	N/A