

STAX 6MM

Wire modules in order as shown on the diagram

Maximum Amperage per lead: 16 Amps @120V

STAX Boost Power Continuation Cable found in (Yellow Labeled bag). Required after each 12th consecutive module per display face.

STAX Controller Cable Kit found in (Red Labeled bag). One cable kit per display face. Includes one Primary Controller Power Cable and one 1st Module Power/Data Cable

Multiple leads can be connected together and share a breaker. Multiple circuits may share the same neutrals. Please follow local NEC Codes & regulations

SECONDARY DISPLAY REAR VIEW
First module connection must start in this corner

PRIMARY DISPLAY REAR VIEW
First module connection must start in this corner

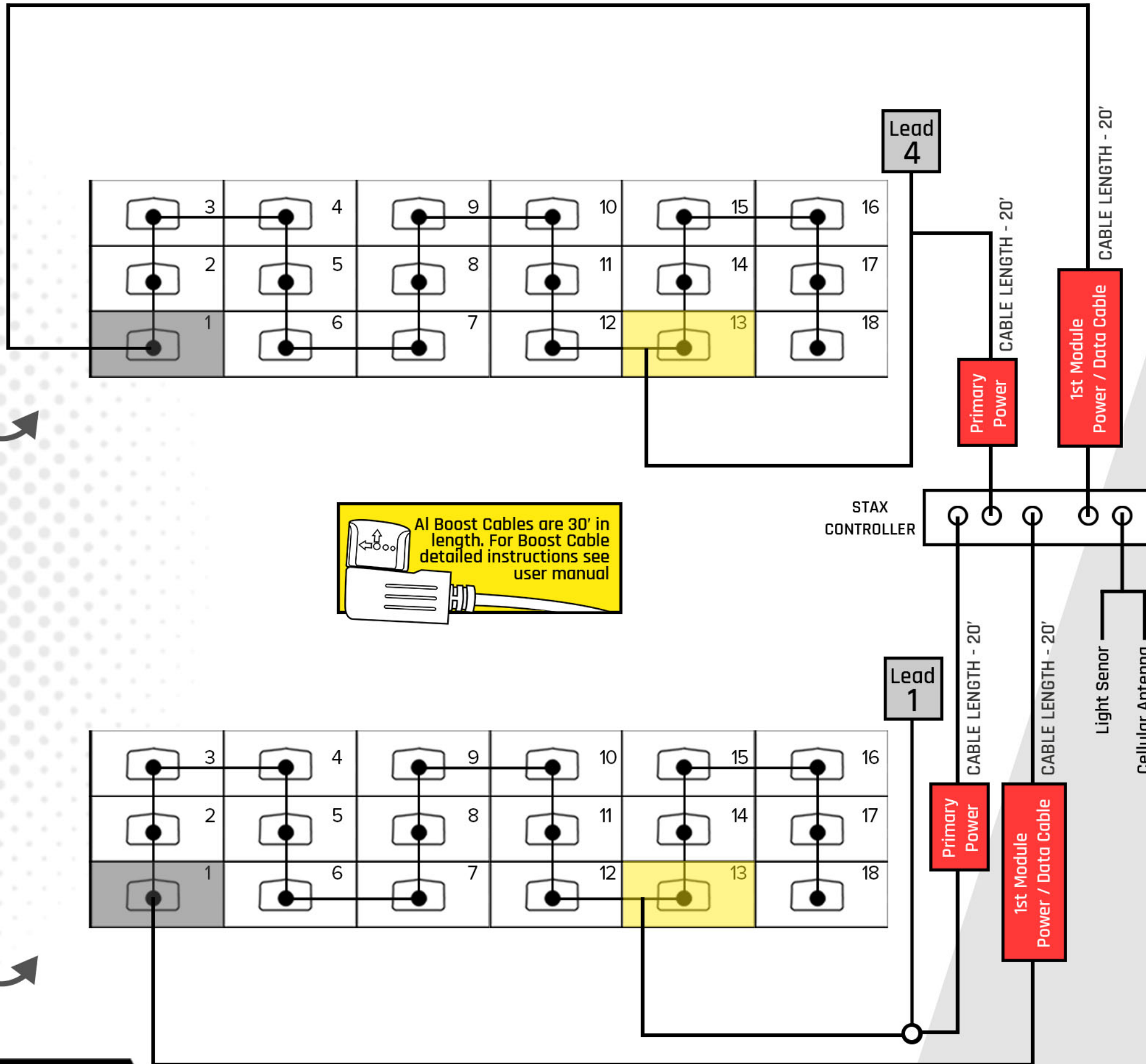

Primary Display

Lead	Max Watts	Avg Watts	Amps @120V
4	1436	769	12.0
5			
6			
Total	1436	769	12.0

Secondary Display

Lead	Max Watts	Avg Watts	Amps @120V
4	1436	769	12.0
5			
6			
Total	1436	769	12.0

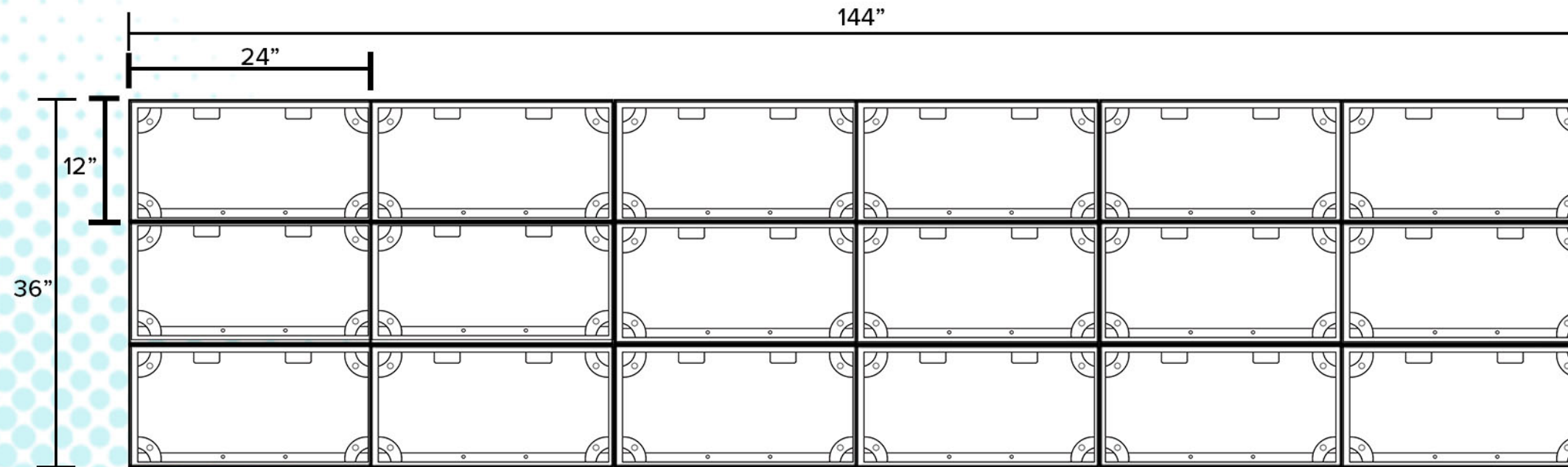

Must lift final assembled sign with a minimum of two lifting points. 330 maximum lbs per lifting pin.

Parts List	Single Face	Double Face
Module	18	36
Controller	1	1
Controller Cable Kit	1	2
Boost Power Cable	1	2

AND

Option 1: Single Frame Assembly	Single Face	Double Face
1' x 2' Frame	18	36
1' x 2' Frame Door (Optional)	18	36

OR

Option 2: Mixed Frame Assembly	Single Face	Double Face
1' x 2' Frame	6	12
1' x 2' Frame Door (Optional)	6	12
2' x 4' Frame	3	6
2' x 4' Frame Door (Optional)	6	12

PRIMARY DISPLAY REAR VIEW

SHACKLE ATTACHMENT

The shackle cables should connect to the lifting pins at an angle of 30 degrees or less to prevent damage to the cabinet frame. Spreader bar should be used when three or more lifting pins are required per face.

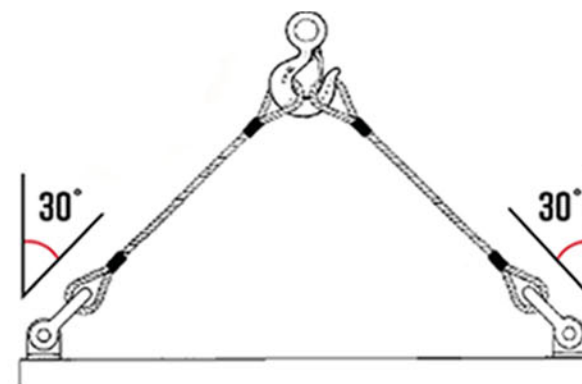

Display Weight	Maximum lbs	Maximum lbs per lifting pin	Number of Pins Per Face
Single Face	292.8	330	2
Double Face	585.6	N/A	N/A



CAUTION